



Platinum

User's Manual

www.viesa.ca / 1-888 438-8444

IMPORTANT

Installation requires an experienced mechanic with specific knowledge in the installation of the VIESA Ecological Cooler. Installation, disassembly, repairs and maintenance must be performed by an Authorized Installer. Authorized Installer must use proper protective equipment when installing the system.

Improper installation or use of unauthorized parts can cause malfunctions, loss of battery life or other consequences which may result in serious injury.

Manufacturer or Distributor will not be responsible for injuries or damages resulting from misuse of equipment, use contrary to operating instructions or installation by any person other than an Authorized Installer.

Information contained in this manual is subject to change. Manufacturer reserves the right, without notice, to make changes in equipment design or components as progress in engineering, manufacturing or technology may warrant.

World-wide Patents

VIGIA is a trademark of Col-Ven S.A.

INTRODUCTION

VIESA delivers cool air to the truck's cabin without running the truck's engine.

Cooling is generated by vaporized cool water delivered by a self-contained electrical motor. During operation it only consumes water and it makes no use of internal combustion engines, nor does it use chemical coolants or emit gases into the atmosphere.

VIESA is totally ecological and provides the driver with a healthier rest and a more comfortable driving condition, increasing driver satisfaction.



CONTROL PANEL AND REMOTE CONTROL

Important: Before turning on the system make sure that one of the cab's windows is open 2 or 3 cm and that all other openings or vents are closed preventing outside hot air from entering the cab.

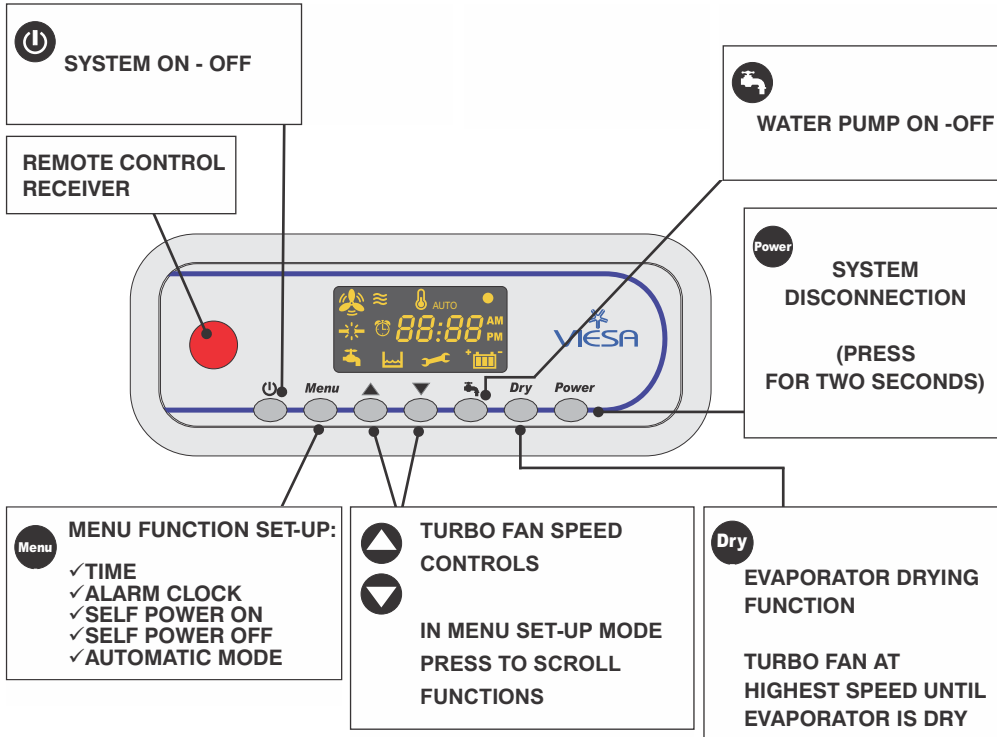

By default time is in 24H format and temperature is shown in °C.

The remote control performs all the functions detailed above.



WARNING:

- Keep batteries away from children. Wrong use may cause fire, explosion or burns. Batteries are not rechargeable. Do not expose batteries to heat in excess of 100°C. Use only AAA batteries.

- Dispose batteries in accordance with local regulations.



DISPLAY INFORMATION

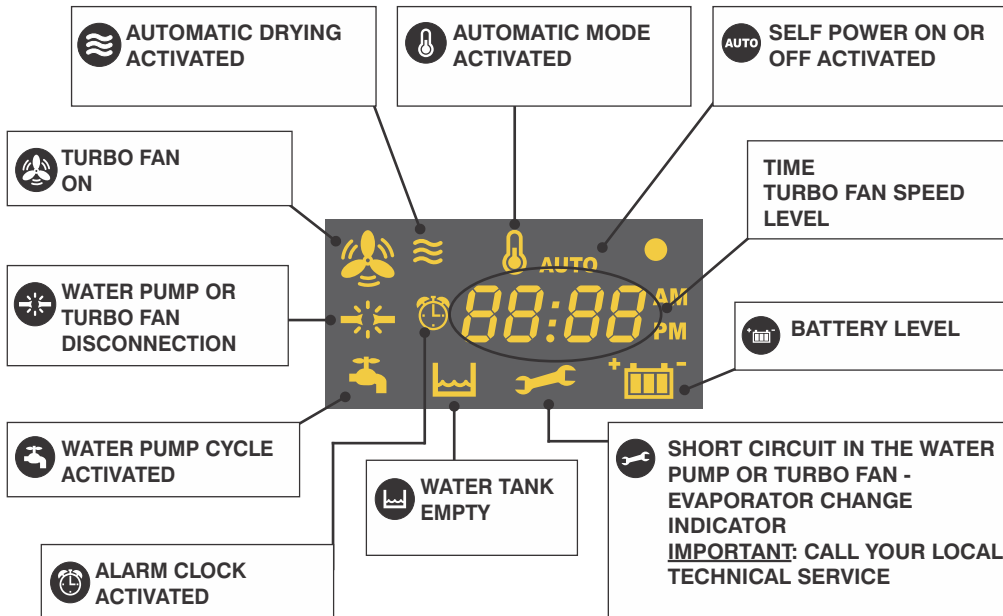



OPERATION

PERMANENT DISPLAY INFORMATION



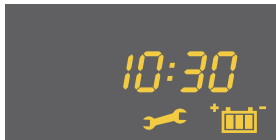



- Clock.
- Battery level: at low battery voltage, a  blinking indicator will appear and the turbo fan speed will start slowing down



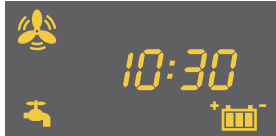

When  is permanently displayed, change the evaporator. Call your local technical service.



TURBO FAN



By pressing  the turbo fan  and the water pump  will be activated.

By pressing  again, the turbo fan  and the water pump  will be disconnected.



There are 8 turbo fan speeds, which can be selected by pressing  or .

Note: keeping the up or down button pressed will vary turbo fan speeds in sub-levels (a total of 24). These sub-levels will not be displayed and will not emit any sound.

WATER PUMP



By pressing  the water pump will turn off.

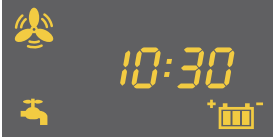



Pressing  again will turn the water pump cycle on.





ERROR MESSAGES



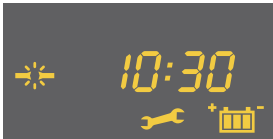

If the turbo fan is disconnected  is displayed and the system will make a sound. This indicator will disappear after the problem is solved and the system turned on by pressing .

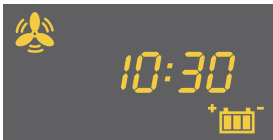

If turbo fan battery consumption is abnormal,  and  will be displayed and the system will make a sound. These indicators will disappear after the problem is solved and the system is turned on by pressing .



If there is damage to internal electrical components  will blink and the system will turn off. These indicators will disappear after the problem is solved and the system is turned on by pressing .



If there is not enough water in the tank, the pump will not work,  will be displayed and the system will make a sound.



 will turn off when pouring water in the tank.



If the water pump is disconnected,  will be displayed and the system will make a sound.

This indicator will disappear after the problem is fixed and the pump cycle is turned on by pressing .



If water pump battery consumption is abnormal,  and  will be displayed and the system will make a sound.

This indicator will disappear after the problem is fixed and the pump cycle is turned on by pressing .



SYSTEM SET UP

Use  to set up the following:

- Clock time
- Alarm
- Self power on
- Self power off
- Automatic mode

CLOCK TIME



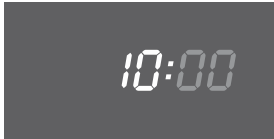

Press  until **00:00** is displayed and then press .

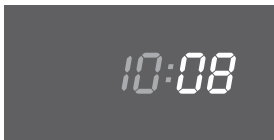

The hour blinks, press  or  to set the hour.



Press  to select the minutes.
Use  or  to set the minutes.

To confirm set time wait 5 seconds or press .

ALARM



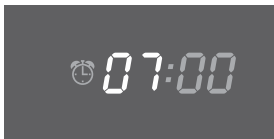

Press  until  is displayed and then press .



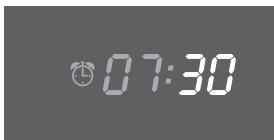

The hour blinks, press  or  to set the hour.

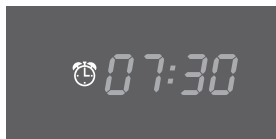

Press  to select the minutes.
Use  or  to set the minutes.



Press  and  blinks

Press  to activate or press  to cancel.

Note: To confirm alarm wait 5 seconds or press 

To turn off the alarm press any key from the control panel or remote control, except for 

SELF POWER ON

It allows to turn on the system automatically at an established time.



Use  until  and  appear and then press . Program the clock (see "Clock Time").



Use  to select .

Then  blinks, press  to activate it or press  to cancel.

Note: To confirm self power on wait 5 seconds or press .

SELF POWER OFF

It allows to turn off the system automatically at an established time.



Use  until  is displayed and then press . Program the clock (see "Clock Time").



Using ,  is selected.

Then  blinks, press  to activate it or press  to cancel.

Note: To confirm self power off wait 5 seconds or press 

Self Power Off can be set even when the equipment is turned off.

AUTOMATIC MODE

It adjusts automatically the speed of the turbo fan according to the exterior temperature.



Use **Menu** until  appears and then press .



Then  blinks, press  to activate it or press  to deactivate it.

Note: To confirm automatic mode wait 5 seconds or press .

In Automatic Mode turbo fan and water pump will not be turned off even if exterior temperature decreases excessively. Turbo fan will continue working at minimum speed.

AUTOMATIC DRYING

This function dries automatically the evaporator.

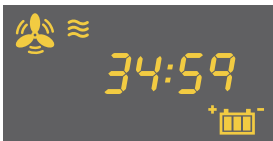

Activate Automatic Drying when the system will not be used for more than 48 hs to avoid bad smells when restarting the system.



Press **Dry** and drying will start with a countdown until process is completed.
To cancel drying press **Dry**.

*By default, the drying process lasts 35 minutes.
Drying time can be re-configured by Authorized Installer.*

SYSTEM DISCONNECTION

When pressing for 2 seconds the button , the equipment will disconnect completely (Including the display). *To re-connect press .*

MAXIMUM TIME OF SERVICE

Every time the equipment is turned on with , it will work for a maximum period of time previously established and then it will turn off automatically. By default, this period lasts 9 hours.

Maximum Time of Service can be re-configured by Authorized Installer.

GENERAL RECOMMENDATIONS

When  is displayed, call your local technical service.

During short stops leave the equipment on so as to keep the cabin fresh.

The system will delay in cooling until the evaporator is totally wet.

▲ *Do not use fuses higher than 15 Amp.*

The system will self disconnect automatically under low voltage to prevent battery damage.

Use only clean water.

The system consumes between 2 to 5 liters of water per hour depending on exterior temperature.

▲ *When performing system maintenance or when the evaporator has been removed, the system **MUST BE DISCONNECTED**.*

▲ *System must not be turned on with evaporator removed.*

Keep the water tank clean: At every 200 hours of use:

- Drain all the water from the tank by removing the drain plug.
- Rinse with clean water.
- Pour one bottle of VIESA scented cleansing fluid and top up tank with clean water. If using Calfa Bas, change package every 6 months.

WITH VIESA FLUID



WITH GRANULATED CALFA BAS



Do not use chemical products to clean the control panel.

Every 2 months or according to working conditions:

- Submerge the evaporator in water with bleach(1).
- Clean the grids of the air entrance(2).
- Clean the filter of the collector tray(3).

Once a year replace the evaporator (1).

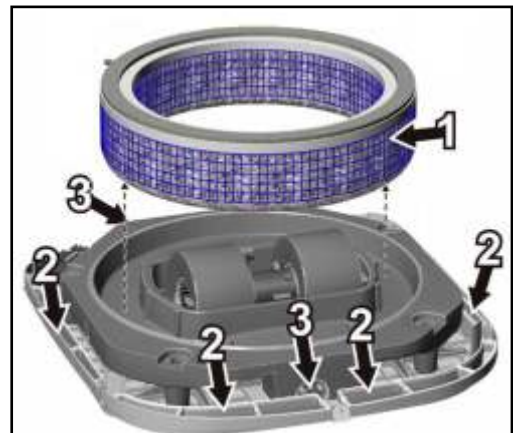

LIMITED WARRANTY

This limited warranty is provided to the original buyer only and covers the VIESA ECOLOGICAL CAB COOLER (the "Product") manufactured by Col-Ven S.A. (the "Manufacturer") and distributed by RCR Systems Limited (the "Distributor").

The warranty period is two years from date of original purchase by the buyer. During this period, if the product is found to be defective in mechanical or electrical materials or workmanship during normal use, it will be repaired or replaced at no charge to the buyer. The buyer will be required to show date and proof of purchase and to return the Product pre-paid to an Authorized Dealer.

THIS LIMITED WARRANTY DOES NOT COVER, AND MANUFACTURER OR DISTRIBUTOR WILL NOT BE RESPONSIBLE FOR, THE FOLLOWING:

- Normal wear of parts;
- Failures or defects due to negligent use, misuse, neglect, abuse, use on improper voltage or current, use contrary to operating instructions, accidents, alterations, disassembly, installation, repair or alteration by any person other than an Authorized Dealer, fire, floods or acts of God.
- Products or accessory equipment not manufactured by the Manufacturer.
- Performance of Product when used in combination with other products or equipment not manufactured by the Manufacturer.
- Payments for labour or service to unauthorized representatives or service agents.

Manufacturer or Distributor will not be responsible for loss of time, inconvenience, loss of use of the Product, injury to buyer or other persons or damage to vehicle or property caused by the Product or by its failure to work or for any other incidental, punitive or consequential damages.

The Manufacturer reserves the right to make the final decision on any warranty claim that may be questionable.

This warranty is not transferable.

EXCEPT AS PROVIDED HEREIN, THIS WARRANTY EXPRESSLY EXCLUDES:

- (i) all warranties and conditions, whether express, implied or statutory, including but not limited to warranties and conditions of merchantability for a particular purpose; and
- (ii) any agreements, representations, affirmations, warranties or conditions, whether oral or written, made by any agent, employee or representative of seller.

This warranty sets forth the entire responsibility of Manufacturer and Distributor with respect to the Product. The buyer's exclusive remedy is repair or replacement as stated herein. In no event shall Manufacturer or Distributor's liability exceed the cost of correcting defects as provided herein and any such liabilities will terminate upon expiration of the two year warranty period.

**USER'S MANUAL VIESA PLATINUM
REVISION 001**



P.O.Box 1352 – 1500 Avenue Road
Toronto, Ontario M5M 0A1
CANADA

COLVEN

Ruta 11 Km.814 - Guadalupe Norte
Prov. de Santa Fe (S3574XAB)
ARGENTINA

ORDER ON-LINE

www.viesa.ca / 1-888 438-8444